

# LACAVA

## NAVI

NAV-VS-30

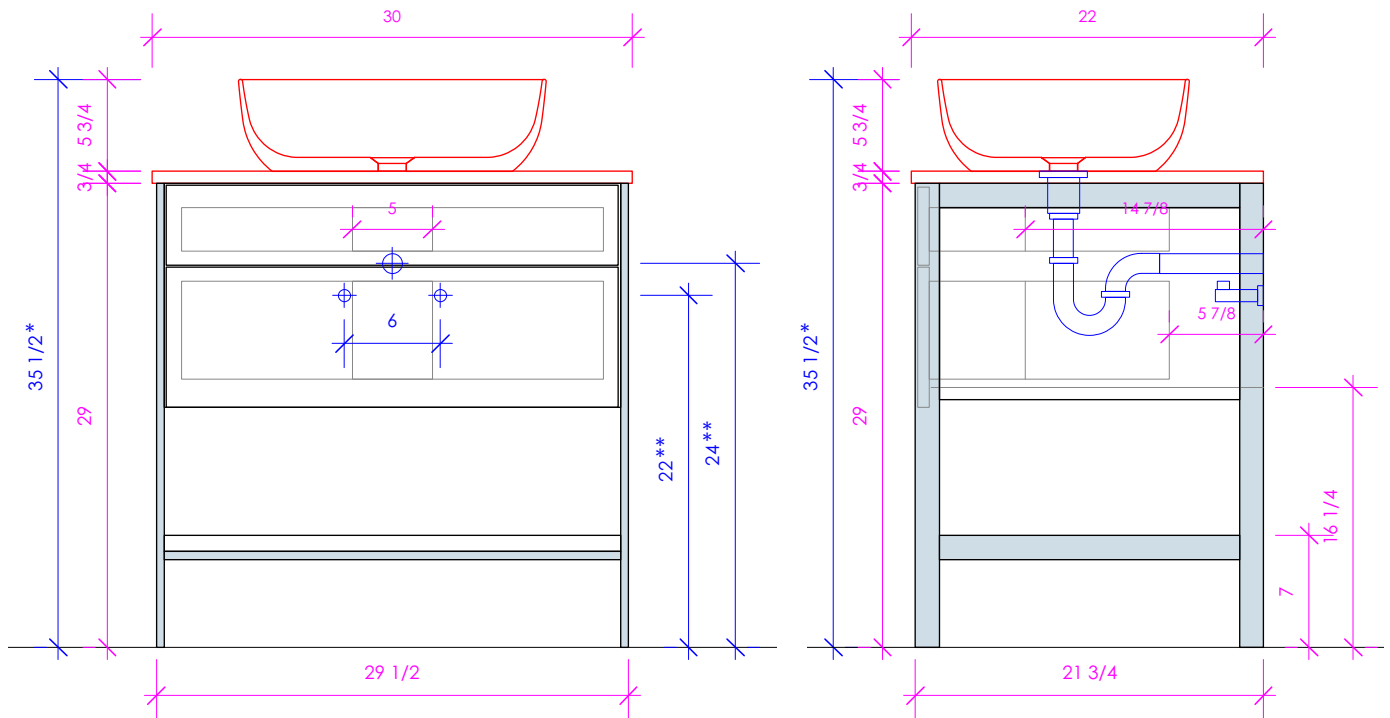

\* Recommended installation height  
\*\* Recommended plumbing location

### FEATURES:

- FLOOR STANDING VANITY
- TWO DRAWERS WITH SELF-CLOSE GLIDES
- DRAWER BOXES STAINED TO REFLECT EXTERIOR FINISH
- DECORATIVE HARDWARE **K550** INCLUDED BUT NOT INSTALLED - CAN BE INSTALLED UPON REQUEST
- USED WITH **NAV-VS-30F** FRAME, **NAV-VS-30T** COUNTERTOP AND **N33** SINK (SOLD SEPARATELY)
- MOUNTING: FULL WOOD BACKING  
(SEE FURNITURE MANUAL)
- PROUDLY HANDMADE IN THE USA
- MANUFACTURED WITH LOW VOC FINISHES AND WOOD FROM RENEWABLE FORESTS

### FINISHES:

#### WOOD:

##### STANDARD:

02 - NATURAL CHERRY  
07 - NATURAL WALNUT  
24 - CLASSIC WALNUT  
20 - ASH GRAY  
06 - WENGE  
33 - AFRICAN MAHOGANY

##### PREMIUM:

22 - GRAY ZEBRA  
31 - WHITE OAK  
27 - RUSTIC  
47 - SMOKY WALNUT

##### LUXURY:

37 - WEATHERED OAK  
52 - SILVER OAK  
50 - HORIZON BLUE

46 - DRIFTWOOD  
\*NEWTERRA ONLY\*

85 - GLOSS WHITE  
88 - GLOSS ARDESIA  
84 - GLOSS TAUPE  
86 - GLOSS BLACK

08T1 - WHITE W/ TEXTURE  
35T1 - ARDESIA W/ TEXTURE  
54T1 - TAUPE W/ TEXTURE  
16T1 - BLACK W/ TEXTURE

#### COUNTERTOP: **NAV-VS-30T**

##### STONE:

WH - BIANCO  
LN - LINAC  
SL - ATHENS

##### QUARTZ:

PR - PURO  
AH - ASH

##### SOLID SURFACE:

M - SATIN WHITE  
G - POLISHED WHITE  
R - MARMO  
V - LAVA  
D - OBSIDIAN

##### CONCRETE:

SND - SAND  
SLT - SLATE  
TER - TERRACOTTA  
CHL - CHARCOAL

#### METALS: **NAV-VS-30F**

##### METAL: **FRAME**

21 - BRUSHED STAINLESS STEEL  
10 - POLISHED STAINLESS STEEL

44 - MATTE BLACK  
MW - MATTE WHITE  
BPW - BRASS POWDER COAT

LACAVA reserves the right to revise any dimension or information on this sheet without notice. Dimensions are nominal and may vary within an industry accepted tolerance of 1/4". Cabinets with 'vanity top' sinks are made to the matching sink and dimensions may vary. LACAVA is not responsible for any cutouts, countertops, or furniture made without the actual product or template. Differences in color, grain, appearance, and texture are inherent in all natural woodwork and should be expected. Variances in these qualities are not deemed manufacturing defects and will not be accepted as valid reasons for return or exchanges. Plumbing specifications are only a guideline and may need alteration based on application.

6630 WEST WRIGHTWOOD  
CHICAGO, IL 60707

PH: 773-637-9600  
FAX: 773-637-9601

LACAVA.COM  
INFO@LACAVA.COM