

LACAVA

Flou

FLO-48LT

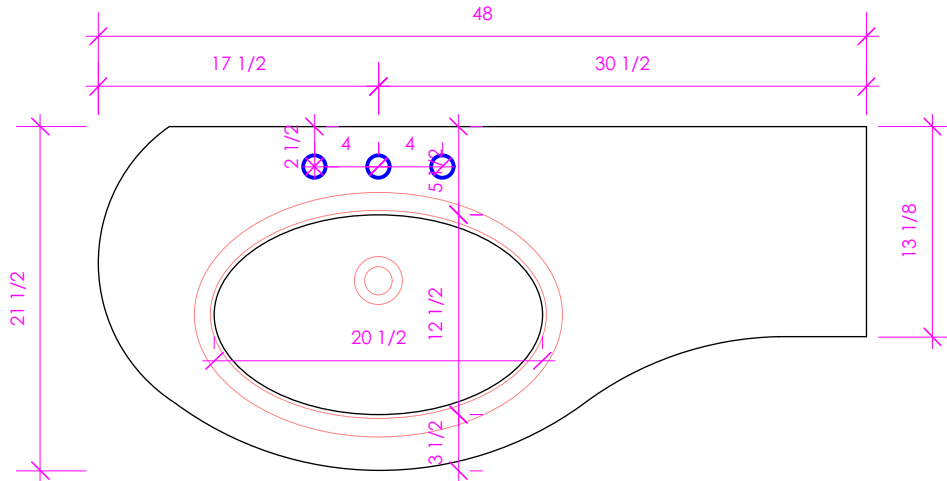

FEATURES:

- EASED EDGES
- USED WITH **33LA** SINK (SOLD SEPARATELY)
- PLEASE SPECIFY **FAUCET HOLE CUTOUTS**
- PROUDLY HANDMADE IN THE USA

FINISHES:

WOOD:

STANDARD:

02 - NATURAL CHERRY
07 - NATURAL WALNUT
24 - CLASSIC WALNUT
20 - ASH GRAY
06 - WENGE
33 - AFRICAN MAHOAGANY

PREMIUM:

22 - GRAY ZEBRA
31 - WHITE OAK
27 - RUSTIC
47 - SMOKY WALNUT

LUXURY:

37 - WEATHERED OAK
52 - SILVER OAK
50 - HORIZON BLUE

46 - DRIFTWOOD
NEWTERRA ONLY

COUNTERTOP:

STONE:

WH - BIANCO
LN - LINAC
SL - ATHENS

2CM OR 3CM
BASED ON
MARKET
AVAILABILITY

QUARTZ:

PR - PURO
AH - ASH

2CM OR 3CM
BASED ON
MARKET
AVAILABILITY

SOLID SURFACE:

M - SATIN WHITE
G - POLISHED WHITE
R - MARMO
V - LAVA
D - OBSIDIAN

1/2" THICKNESS

CONCRETE:

SND - SAND
SLT - SLATE
TER - TERRACOTTA
CHL - CHARCOAL

METALS:

METAL:

21 - BRUSHED STAINLESS STEEL
10 - POLISHED STAINLESS STEEL

44 - MATTE BLACK
MW - MATTE WHITE
BPW - BRASS POWDER COAT

LACAVA reserves the right to revise any dimension or information on this sheet without notice. Dimensions are nominal and may vary within an industry accepted tolerance of 1/4". Cabinets with 'vanity top' sinks are made to the matching sink and dimensions may vary. LACAVA is not responsible for any cutouts, countertops, or furniture made without the actual product or template. Differences in color, grain, appearance, and texture are inherent in all natural woodwork and should be expected. Variances in these qualities are not deemed manufacturing defects and will not be accepted as valid reasons for return or exchanges. Plumbing specifications are only a guideline and may need alteration based on application.

6630 WEST WRIGHTWOOD
CHICAGO, IL 60707

PH: 773-637-9600
FAX: 773-637-9601

LACAVA.COM
INFO@LACAVA.COM

LACAVA

Flou

FLO-48RT

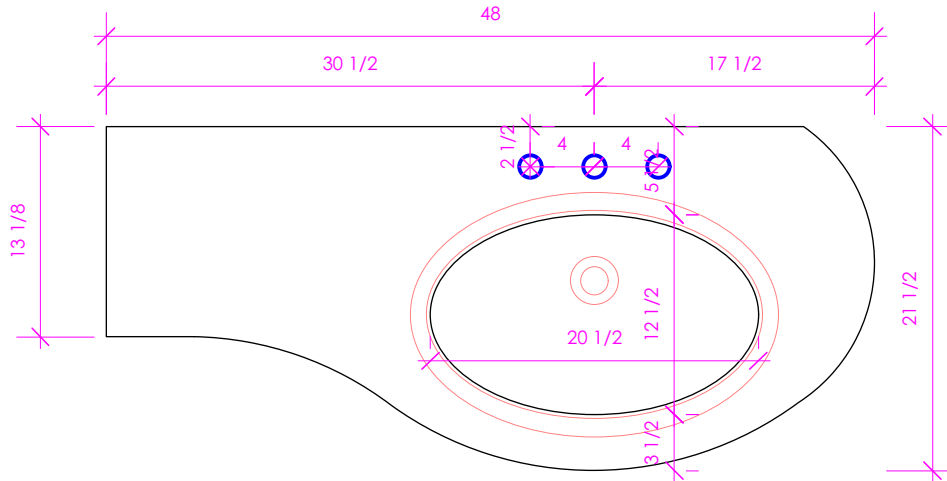

FEATURES:

- EASED EDGES
- USED WITH **33LA** SINK (SOLD SEPARATELY)
- PLEASE SPECIFY **FAUCET HOLE CUTOUTS**
- PROUDLY HANDMADE IN THE USA

FINISHES:

WOOD:

STANDARD:

02 - NATURAL CHERRY
07 - NATURAL WALNUT
24 - CLASSIC WALNUT
20 - ASH GRAY
06 - WENGE
33 - AFRICAN MAHOAGANY

PREMIUM:

22 - GRAY ZEBRA
31 - WHITE OAK
27 - RUSTIC
47 - SMOKY WALNUT

LUXURY:

37 - WEATHERED OAK
52 - SILVER OAK
50 - HORIZON BLUE

46 - DRIFTWOOD
NEWTERRA ONLY

COUNTERTOP:

STONE:

WH - BIANCO
LN - LINAC
SL - ATHENS

2CM OR 3CM
BASED ON
MARKET
AVAILABILITY

QUARTZ:

PR - PURO
AH - ASH

2CM OR 3CM
BASED ON
MARKET
AVAILABILITY

SOLID SURFACE:

M - SATIN WHITE
G - POLISHED WHITE
R - MARMO
V - LAVA
D - OBSIDIAN

1/2" THICKNESS

CONCRETE:

SND - SAND
SLT - SLATE
TER - TERRACOTTA
CHL - CHARCOAL

METALS:

METAL:

21 - BRUSHED STAINLESS STEEL
10 - POLISHED STAINLESS STEEL

44 - MATTE BLACK
MW - MATTE WHITE
BPW - BRASS POWDER COAT

LACAVA reserves the right to revise any dimension or information on this sheet without notice. Dimensions are nominal and may vary within an industry accepted tolerance of 1/4". Cabinets with 'vanity top' sinks are made to the matching sink and dimensions may vary. LACAVA is not responsible for any cutouts, countertops, or furniture made without the actual product or template. Differences in color, grain, appearance, and texture are inherent in all natural woodwork and should be expected. Variances in these qualities are not deemed manufacturing defects and will not be accepted as valid reasons for return or exchanges. Plumbing specifications are only a guideline and may need alteration based on application.

6630 WEST WRIGHTWOOD
CHICAGO, IL 60707

PH: 773-637-9600
FAX: 773-637-9601

LACAVA.COM
INFO@LACAVA.COM